



# Chicago Pneumatic

## Product Instructions

Printed Matter No. 6159991160

Date: 2024-01 Issue No. 01

### Nutrunner

Model:

CP8609-B

CP8609-BT

CP8609-C

CP8609-CT

CP8609-xC

CP8609-xCT



#### **⚠ WARNING**

#### **Read all safety warnings and instructions**

Failure to follow the safety warnings and instructions may result in electric shock, fire and/or serious injury.

**Save all warnings and instructions for future reference**

# Table of Contents

<b>Product Information .....</b>	<b>3</b>
General Information.....	3
Safety Signal Words.....	3
Website .....	3
Overview .....	3
Connected Version.....	3
Product Description.....	4
Technical data.....	5
Service Overview .....	6
Disposal .....	6
<b>Installation.....</b>	<b>7</b>
Installation Instruction.....	7
<b>Operation.....</b>	<b>8</b>
Operating Instructions .....	8
Special precaution.....	8
General Instructions .....	8
Standalone Tools Menu .....	8
Maintenance Menu.....	9
Tools Information Menu .....	10
Unit Selection Menu .....	10
Operating the tool.....	10
<b>Service.....</b>	<b>12</b>
Preventing ESD Problems.....	12
Daily Inspection .....	12
Maintenance Instruction .....	12
<b>Troubleshooting .....</b>	<b>13</b>
Troubleshooting.....	13
Error Codes .....	13

## Product Information

### General Information

#### **WARNING Risk of Property Damage or Severe Injury**

Ensure that you read, understand and follow all instructions before operating the tool. Failure to follow all the instructions may result in electric shock, fire, property damage and/or severe bodily injury.

- ▶ Read all Safety Information delivered together with the different parts of the system.
- ▶ Read all Product Instructions for installation, operation and maintenance of the different parts of the system.
- ▶ Read all locally legislated safety regulations regarding the system and parts thereof.
- ▶ Save all Safety Information and instructions for future reference.

### Safety Signal Words

Safety signs have the following meaning:

DANGER	DANGER indicates a hazardous situation which, if not avoided, <b>will</b> result in death or serious injury.
WARNING	WARNING indicates a hazardous situation which, if not avoided, <b>could</b> result in death or serious injury.
CAUTION	CAUTION, used with the safety alert symbol, indicates a hazardous situation which, if not avoided, could result in minor or moderate injury.
NOTICE	NOTICE is used to address practices not related to personal injury.

### Website

Information concerning our Products, Accessories, Spare Parts and Published Matters can be found on the Chicago Pneumatic website.

Please visit: [www.cp.com](http://www.cp.com).

### Overview

#### Connected Version

To unblock functionalities of CP86 connected versions C, CQ and TC, scan the below QR code and download CPLinQ to your device. Connect your tool to CPLinQ app.



**Product Description**

**CP8609-BT**

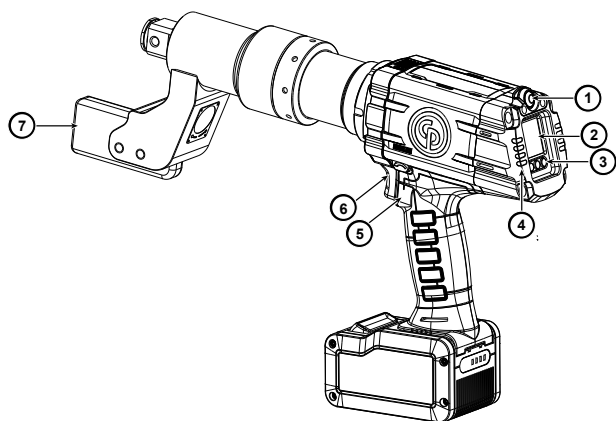

- 1) Second Trigger
- 2) Display screen
- 3) Settings buttons
- 4) Reporting LEDs
- 5) Reverse button
- 6) Principle trigger
- 7) Blade

**CP8609-B**

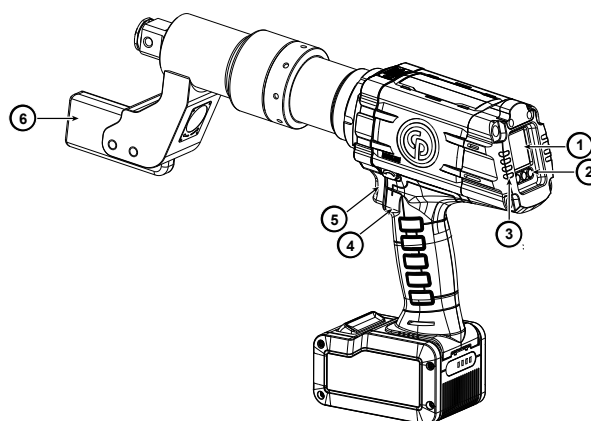

- 1) Display screen
- 2) Settings buttons
- 3) Reporting LEDs
- 4) Reverse button
- 5) Principle trigger
- 6) Blade

**CP8609-C**

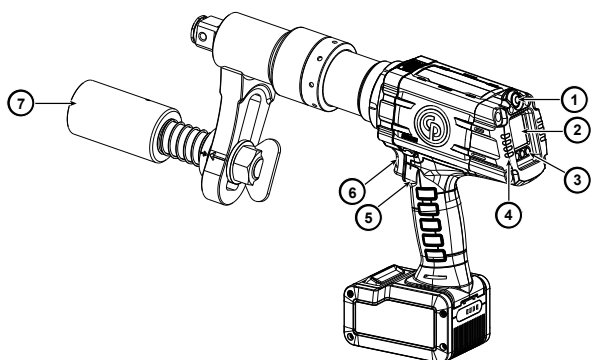

- 1) Second Trigger
- 2) Display screen
- 3) Settings buttons
- 4) Reporting LEDs
- 5) Reverse button
- 6) Principle trigger
- 7) Cup (Optional accessory - see below)

**CP8609-xC**

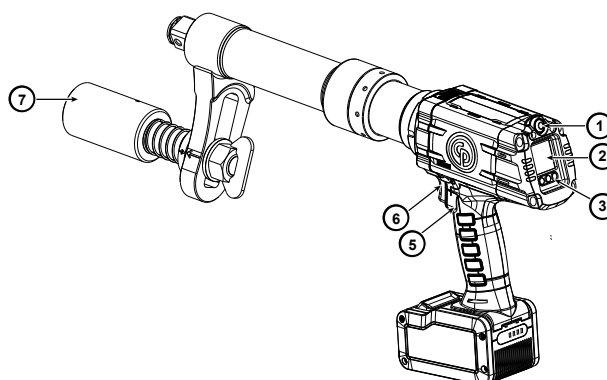

- 1) Second Trigger
- 2) Display screen
- 3) Settings buttons
- 4) Reporting LEDs
- 5) Reverse button
- 6) Principle trigger
- 7) Cup (Optional accessory - see below)

**Accessories**

Accessory	Part Number
Spring Loaded Cup	8940164622
Japanese Cup	8940167401

### Connected Version

CP86 series has two connected versions as given below:

- C
- CQ
- TC

To unblock functionalities of the CP86 connected versions C, CQ and TC, download CPLinQ to your device and connect your tool to CPLinQ app.

### Technical data

	CP8609-B	CP8609-BT	CP8609-C	CP8609-CT	CP8609-xC	CP8609-xCT
Free Speed (rpm)	15	15	15	15	15	15
Max. Ambient Storage Temperature (°C)	60	-60	60	60	60	60
Min. Ambient Storage Temperature (°F)	-4	-4	-4	-4	-4	-4
Min. Ambient Storage Temperature (°C)	-20	-60	-20	-20	-20	-20
Max. Ambient Storage Temperature (°F)	140	140	140	140	140	140
Min. Ambient Operating Temperature (°C)	0	0	0	0	0	0
Min. Ambient Operating Temperature (°F)	32	32	32	32	32	32
Max. Ambient Operating Temperature (°C)	60	60	60	60	60	60
Max. Ambient Operating Temperature (°F)	140	140	140	140	140	140
Max. Recommended Ambient Charging Temperature (°C)	45	45	45	45	45	45
Max. Recommended Ambient Charging Temperature (°F)	113	113	113	113	113	113
Min. Recommended Ambient Charging Temperature (°C)	0	0	0	0	0	0
Min. Recommended Ambient Charging Temperature (°F)	32	32	32	32	32	32
Max. Torque Rev. (Nm)	900	900	900	900	900	900
Max. Torque Rev. (ft.lb)	665	665	665	665	665	665
Square Size (")	1	1	1	1	1	1
Battery capacity (Ah)	2.5	2.5	2.5	2.5	2.5	2.5
Battery voltage (V)	36	36	36	36	36	36
Weight (kg)	5.8	5.8	5.6	5.6	6.9	6.9
Weight (lb)	12,7	12,7	12,3	12,3	15.2	15.2
W (mm)	77	77	77	77	77	77
W (")	3	3	3	3	3	3
L (mm)	380	380	380	380	495	495
L (")	14.96	14.96	14.96	14.96	19.5	19.5
L1 (mm)	437	437	491	491	605	605
L1 (")	17.2	17.2	19.33	19.33	23.82	23.82
H (mm)	218	218	218	218	218	218
H (")	8.6	8.6	8.6	8.6	8.6	8.6
H1 (mm)	285	285	285	285	285	285
H1 (")	11.22	11.22	11.22	11.22	11.22	11.22

## *Service Overview*

### **Disposal**

- The disposal of this equipment must follow the legislation of the respective country.
- All damaged, badly worn or improperly functioning devices **MUST BE TAKEN OUT OF OPERATION.**

## Installation

### *Installation Instruction*

#### **Battery Pack and Charger**

It is recommended to use following battery pack and charger with the CP86 models:

<b>Battery Pack</b>	<b>Charger</b>
CP36XP25 (8940176068)	CP18-36CH (8940176069)

#### **Battery Wake up**

Remove the white protective sticker and plug the battery to the recommended charger.

#### **Battery Installation**

1. Attach the battery pack to the tool. Press it until a locking sound can be clearly heard.
2. To remove the battery pack press the button on the battery and push it out.

## Operation

### Operating Instructions

#### Special precaution

**⚠ WARNING Crushing Hazard**

The Dual trigger forces the user to use both hands to operate the tool. If not used, the operator can accidentally start the tool while adjusting the reaction bar, thus resulting in a serious hand injury.

- ▶ Make sure the tool cannot be started once the Dual trigger has been released.
- ▶ Always test the tool by first releasing the trigger of the Dual trigger, then push the trigger of the tool. If the tool starts; stop work.

#### General Instructions

The tool may only be used together with the associated torque reaction bar, which is adapted to the screw joint application concerned.

**⚠ WARNING Crushing Hazard**



0690 9110 05 9830 0144 00

Check the rotational direction of the tool before start! A start in an unexpected rotational direction can cause bodily injury or property damage. Moving parts can crush and cut.

- ▶ Make sure that the rotational direction of the tool is correct before starting the tool.
- ▶ Keep hands and fingers away from moving parts.

#### Standalone Tools Menu

CP8609-BT

CP8609-CT

CP8609-xCT

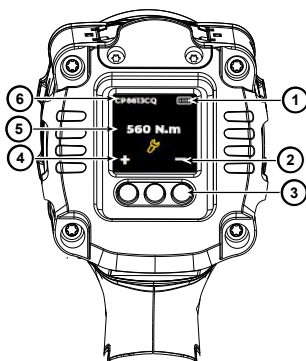

- 1) Battery level/Bluetooth connection (C, CQ, TC version)
- 2) Action for button
- 3) Button for menu navigation an
- 4) Action for button
- 5) Application Information
- 6) Tool

CP8609-B

CP8609-C

CP8609-xC

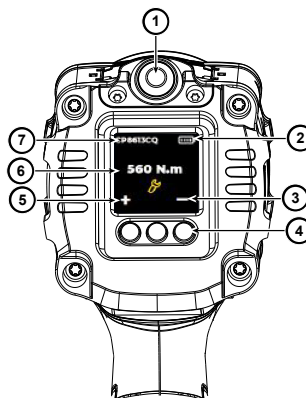

- 1) Second Trigger
- 2) Battery level/Bluetooth connection (C, CQ, TC version)
- 3) Action for button
- 4) Button for menu navigation an
- 5) Action for button
- 6) Application Information
- 7) Tool



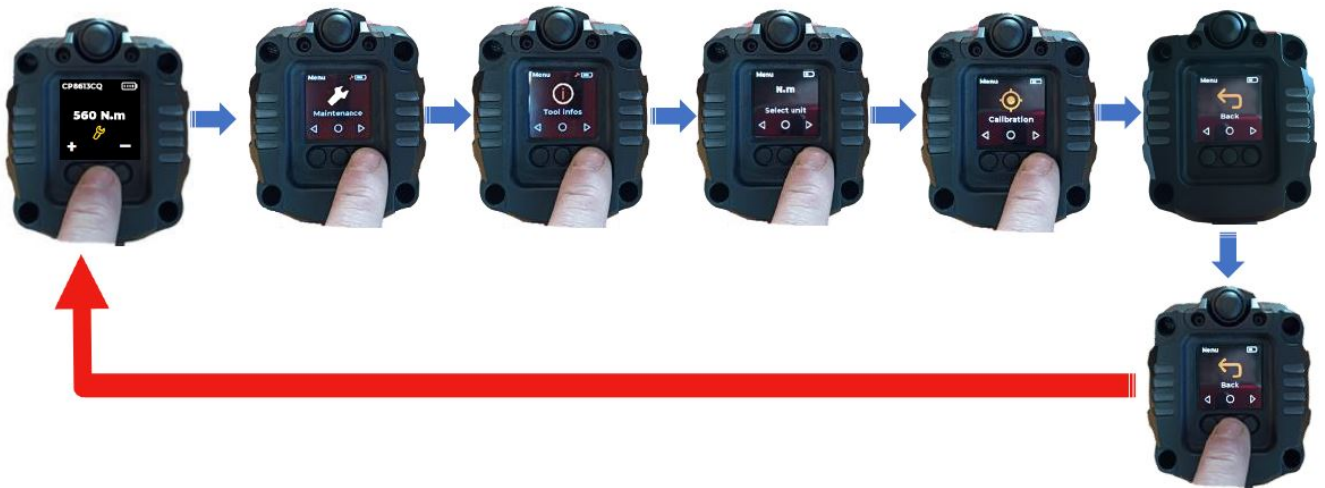

1. Press the menu button. Access following menus by pressing navigation buttons.
  - Maintenance
  - Tool Infos
  - Select unit
  - Calibration
2. When screen shows "Back" on display, press menu button to return on the main menu.

### Maintenance Menu



### Tools Information Menu



### Unit Selection Menu



### Operating the tool

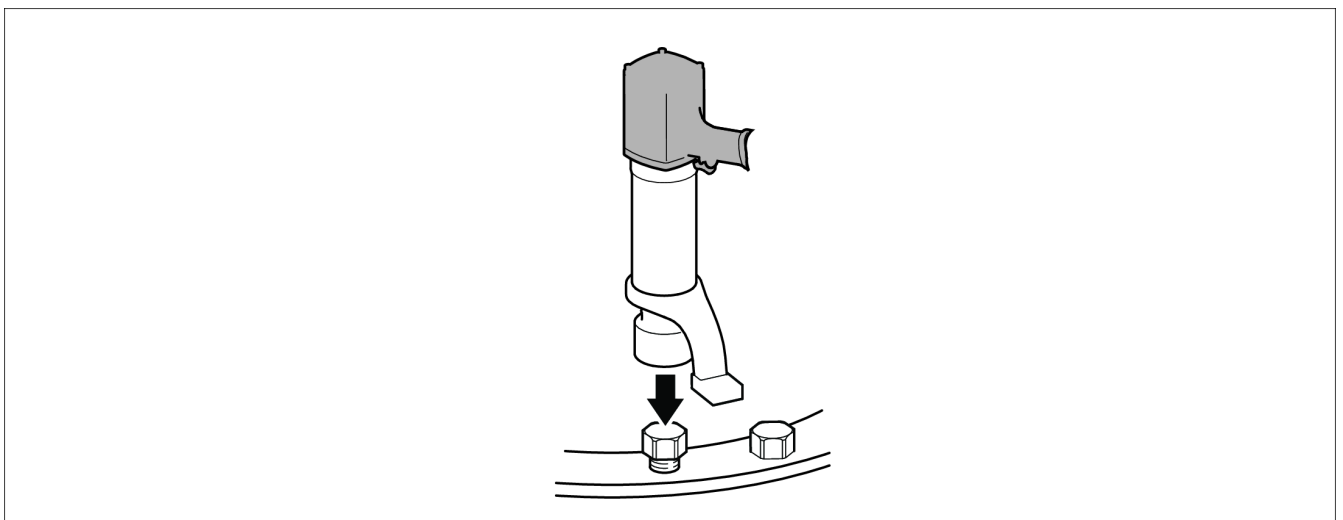

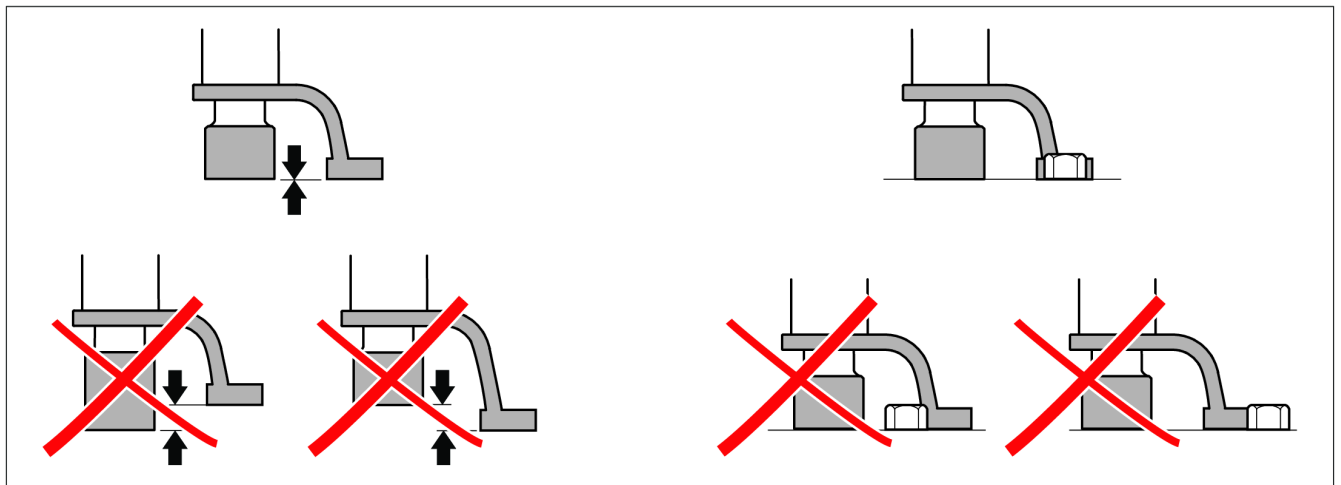
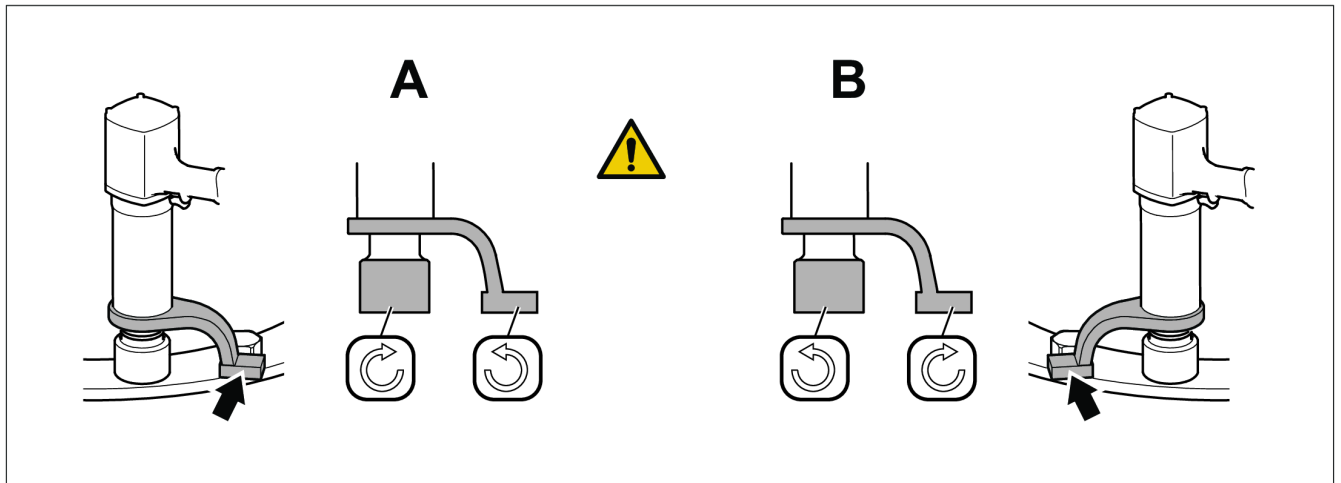

1. Press the menu button.
2. Select the correct mode.
3. Press the reverse button to select the right direction.
4. Increase or decrease torque value by pressing left and right button respectively. Set the required torque.
5. Place the socket on the nut, make sure that it is fully engage the nut.
6. Make sure that reaction arm is firmly rested on adjacent nut.
7. Press and keep pressure on second trigger.
8. Press and keep pressure on principal trigger.
9. Keep the triggers pressed till the end of the operation.
10. Check the operation status on reporting LEDs.
  - Green - OK
  - Red - Not OK

## Service

### Preventing ESD Problems

The components inside the product and controller are sensitive to electrostatic discharge. To avoid future malfunction, make sure that service and maintenance is carried out in an ESD approved work environment. The figure below shows an example of an appropriate service work station.

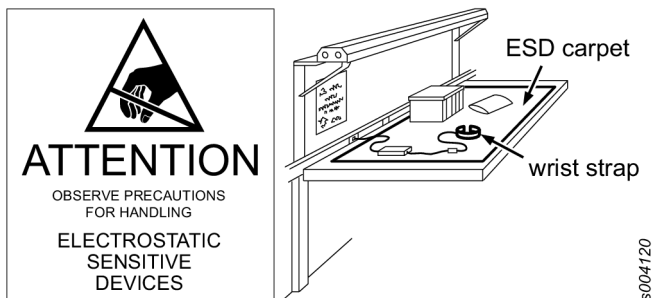

### Daily Inspection

- Make sure that the tool is in good condition.
- Make sure that sockets and reaction bar have no visual damage.
- Listen to make sure that there is no unexpected noise when running the tool.

### Maintenance Instruction

#### **WARNING Cutting Hazards**

Sharp objects can cause injuries, especially to the hands.

- ▶ Always wear cut resistant gloves when changing components.
- Maintenance and repair work must be carried out by qualified personnel using only original spare parts. Contact the manufacturer or your nearest authorised dealer for advice on technical service or if you require spare parts.
- Use clean clothes to remove dirt, dust, oil, grease, etc.
- After the cleaning, inspect all parts. Replaced damaged and worn parts immediately.





## Troubleshooting





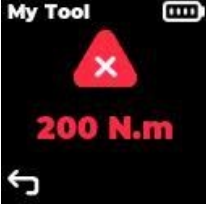

### Troubleshooting













The table below describes the most common problems, possible cause and solution to troubleshoot them. If the problem occurs again, contact your CP representative for support.

Problem	Possible Cause	Solution
Tool does not start	Battery	Check battery power, change battery in case of low charge level
Tool shut offs prematurely/before cycle completion	Tool temperature is too high. One of the triggers has been released during tightening	Cool down the tool Maintain both triggers until end of tightening
Tool cannot connect to CPLINQ		Check that your Bluetooth is active on your terminal

### Error Codes

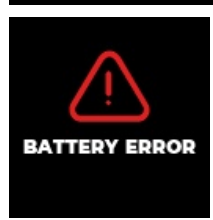
Error	Possible Cause	Solution
	Triggers have been used in bad order	Press the second trigger first (1) and maintain, then press main trigger (2) and maintain both until end of tightening (refer to product description)
	One of the triggers has been released during tightening. Torque or angle achieved is shown	Maintain both triggers until end of tightening
		
	Torque higher than maximum authorized OR angle not achievable because of tool capacity exceeded	
	The tool has detected a rehit. You are probably trying to tighten an already tightened bolt	

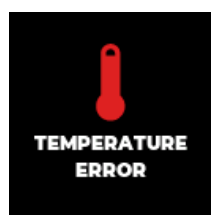
Error	Possible Cause	Solution
 <p>The error icon shows a red warning triangle with an exclamation mark inside, on a black background. Above the triangle is the text 'My Tool' and a battery level indicator. Below the triangle is the text 'OPERATING TIME MAINTENANCE'.</p>	<p>The nutrunner needs a maintenance due to time of operation</p>	<p>Contact service center</p>
 <p>The error icon shows a red warning triangle with an exclamation mark inside, on a black background. Above the triangle is the text 'My Tool' and a battery level indicator. Below the triangle is the text 'DROP MAINTENANCE'.</p>	<p>The nutrunner needs a maintenance due to too many drops</p>	
 <p>The error icon shows a red warning triangle with an exclamation mark inside, on a black background. Above the triangle is the text 'My Tool' and a battery level indicator. Below the triangle is the text 'FORWARD MAINTENANCE'.</p>	<p>The nutrunner needs a maintenance due to number of tightening</p>	
 <p>The error icon shows a red warning triangle with an exclamation mark inside, on a black background. Above the triangle is the text 'My Tool' and a battery level indicator. Below the triangle is the text 'REVERSE MAINTENANCE'.</p>	<p>The nutrunner needs a maintenance due to number of untightening</p>	
 <p>The error icon shows a red warning triangle with an exclamation mark inside, on a black background. Above the triangle is the text 'My Tool' and a battery level indicator. Below the triangle is the text 'LOW BATTERY' and a left-pointing arrow.</p>	<p>Level of battery is under 25%</p>	<p>Replace battery by fully loaded battery as soon as possible. For battery wake up procedureInstallation Instruction</p>
 <p>The error icon shows a battery symbol with a red exclamation mark inside, on a black background. Below the battery symbol is the text 'EMPTY BATTERY'.</p>	<p>Level of battery is under 5%</p>	<p>Replace battery by fully loaded battery, tool will turn off (refer to battery wake up procedure if needed)</p>

Error	Possible Cause	Solution
 <p>My Tool <span>    </span>    <b>FLASH ERROR</b></p>	<p>Tool system issue</p>	<p>Contact service center</p>
 <p>My Tool <span>    </span>    <b>FAN ISSUE</b></p>		
 <p>  <b>MEMORY ERROR</b></p>		
 <p>My Tool <span>    </span>    <b>DRIVE ERROR</b></p>		
 <p>  <b>BATTERY ERROR</b></p>	<p>The tool is unable to connect with the battery.</p>	<ol style="list-style-type: none"> <li>1. Check if you are using the right Battery (8940176068)</li> <li>2. If the problem occurs again, contact your CP representative for support.</li> </ol>
 <p>  <b>TEMPERATURE ERROR</b></p>	<p>The tool is out off functional temperature range.</p>	<ol style="list-style-type: none"> <li>1. Wait the tool cool down</li> <li>2. Reduce duty cycle</li> <li>3. If the problem occurs again, contact your CP representative for support.</li> </ol>

---

### **ABOUT CHICAGO PNEUMATIC**



At Chicago Pneumatic, we have a passion for performance and long-lasting partnerships with our customers in industrial applications, construction, infrastructure and maintenance. Since 1901, we have been committed to reliability based on technology and trust.

**TO LEARN MORE, VISIT [WWW.CP.COM](http://WWW.CP.COM)**

